

TS8GJF185

8GB USB2.0 JetFlash®

Description

TS8GJF185 is a 8GB USB Flash Drive with 1 pcs of 8Gx8 Flash Memory assembled on a printed circuit board.

Outline

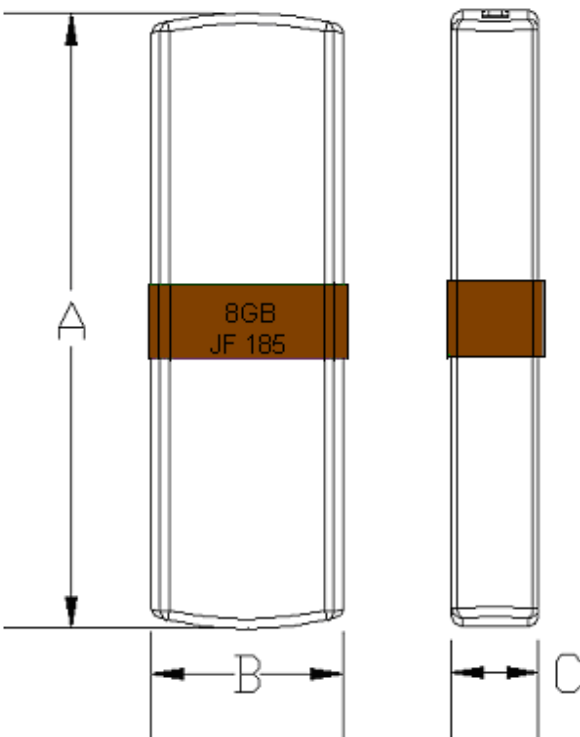

Features

- Frame Color: Bronze
- USB 2.0 compatible, true Plug and Play
- Powered directly via the USB port. No external power or battery needed
- LED indicates the usage status of JetFlash®
- JetFlash elite software pack includes (Windows 2000/XP/Vista/Windows 7 only):
 - Favorites Function: store all your favorite website addresses on the JetFlash®
 - AutoLogin Function: automatically login to websites where you have a password
 - Secret-Zip Function: compress and/or password protect saved files using 256-bit AES encryption
 - PC-Lock Function: makes JetFlash® a key to your computer
 - E-Mail Function: use your JetFlash® to securely send, receive and save e-mails
 - DataBackup Function: backup, restore and synchronize your data

System Requirement

- Hardware: Desktop or notebook computer with USB port
- Operating System: Windows® 2000 SP4, Windows® XP SP2, Windows® Vista, Windows® 7 and Mac™ OS 9.0 or later, Linux™ Kernel 2.4.2 or later

Dimensions

Side	Millimeters	Inches
A	49.5 ± 1.00	1.95 ± 0.04
B	15.8 ± 1.00	0.62 ± 0.04
C	7.4 ± 1.00	0.29 ± 0.04

Block Diagram

- With 1 pcs of 8Gx8 Flash Memory

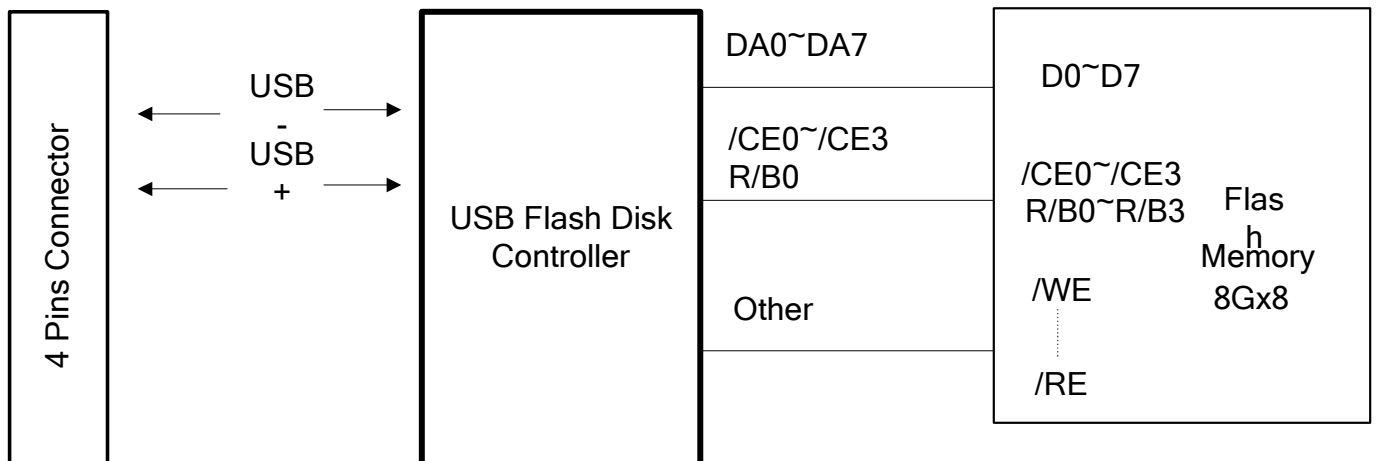

TS8GJF185

8GB USB2.0 JetFlash®

Pinouts

Pin No.	Pin Name
01	VCC
02	USB-
03	USB+
04	VSS

Pin Identification

Symbol	Function
USB-	USB differential signal:
USB+	The pairs are used to transmit Data/Address/Command
VSS	Ground
VCC	USB power input

Specifications

Storage Capacity	8GB
Data Retention	10 years
Erase Cycles	>100,000 times
Connector Durability	10,000 times
System Performance	Read: 16 MB/sec (max.), Write: 12 MB/sec (max.)
Power Supply	DC 5V±10%, Max current : 200 mA
Temperature Range	Operation: 0-70°C, Storage: -20°C-75°C
Weight	15g
Certificates	CE, FCC, BSMI

Above technical information is based on industry standard data and tested to be reliable. However, Transcend makes no warranty, either expressed or implied, as to its accuracy and assumes no liability in connection with the use of this product. Transcend reserves the right to make changes in specifications at any time without prior notice.